

DATA SHEET

Product Name Anti-Surge Thick Film Chip Resistors

Part Name AS Series

Uniroyal Electronics Global Co., Ltd.

88#, Longteng Road, Economic & Technical Development Zone, Kunshan, Jiangsu, China

Tel +86 512 5763 1411 / 22 /33

Email marketing@uni-royal.cn

Manufacture Plant Uniroyal Electronics Industry Co., Ltd.

Aeon Technology Corporation

Royal Electronic Factory (Thailand) Co., Ltd.

Royal Technology (Thailand) Co., Ltd.

1. Scope

- 1.1 This datasheet is the characteristics of Anti-Surge Thick Film Chip Resistors manufactured by UNI-ROYAL.
- 1.2 Superior Anti-surge Voltage performance
- 1.3 Suitable for both wave& re-flow soldering
- 1.4 AEC-Q200 qualified
- 1.5 Application AV adapters, LCD back-light camera strobe etc.
- 1.6 Compliant with RoHS directive.
- 1.7 Halogen free requirement.

2. Part No. System

Part No. includes 14 codes shown as below:

2.1 1st~4th codes: Part name. E.g.: AS02,AS05,AS06,AS07,AS10,AS12.

2.2 5th~6th codes: Power rating.

E.g.: W=Normal Size "1~G" = "1~16"

Wattage	3/4	1/2	1/4	1/8	0.6	1.5	2
Normal Size	07	W2	W4	W8	06	1A	2W

If power rating is equal or lower than 1 watt, 5th code would be "W" and 6th code would be a number or letter.

E.g.: W2=1/2W W4=1/4W

2.3 7th code: Tolerance. E.g.: D=±0.5% F=±1% G=±2% J=±5% K= ±10%

2.4 8th~11th codes: Resistance Value.

2.4.1 If value belongs to standard value of E-24 series, the 8th code is zero, 9th~10th codes are the significant figures of resistance value, and the 11th code is the power of ten.

2.4.2 If value belongs to standard value of E-96 series, the 8th~10th codes are the significant figures of resistance value, and the 11th code is the power of ten.

2.4.3 11th codes listed as following:

0=10⁰ 1=10¹ 2=10² 3=10³ 4=10⁴ 5=10⁵ 6=10⁶ J=10⁻¹ K=10⁻² L=10⁻³ M=10⁻⁴

2.5 12th~14th codes.

2.5.1 12th code: Packaging Type. E.g.: C=Bulk T=Tape/Reel

2.5.2 13th code: Standard Packing Quantity.

4=4,000pcs 5=5,000pcs C=10,000pcs D=20,000pcs E=15,000pcs

Chip Product: BD=B/B-20000pcs TC=T/R-10000pcs

2.5.3 14th code: Special features.

E = Environmental Protection, Lead Free, or Standard type.

3. Ordering Procedure

(Example: AS06 0.6W ±5% 10KΩ T/R-5000)

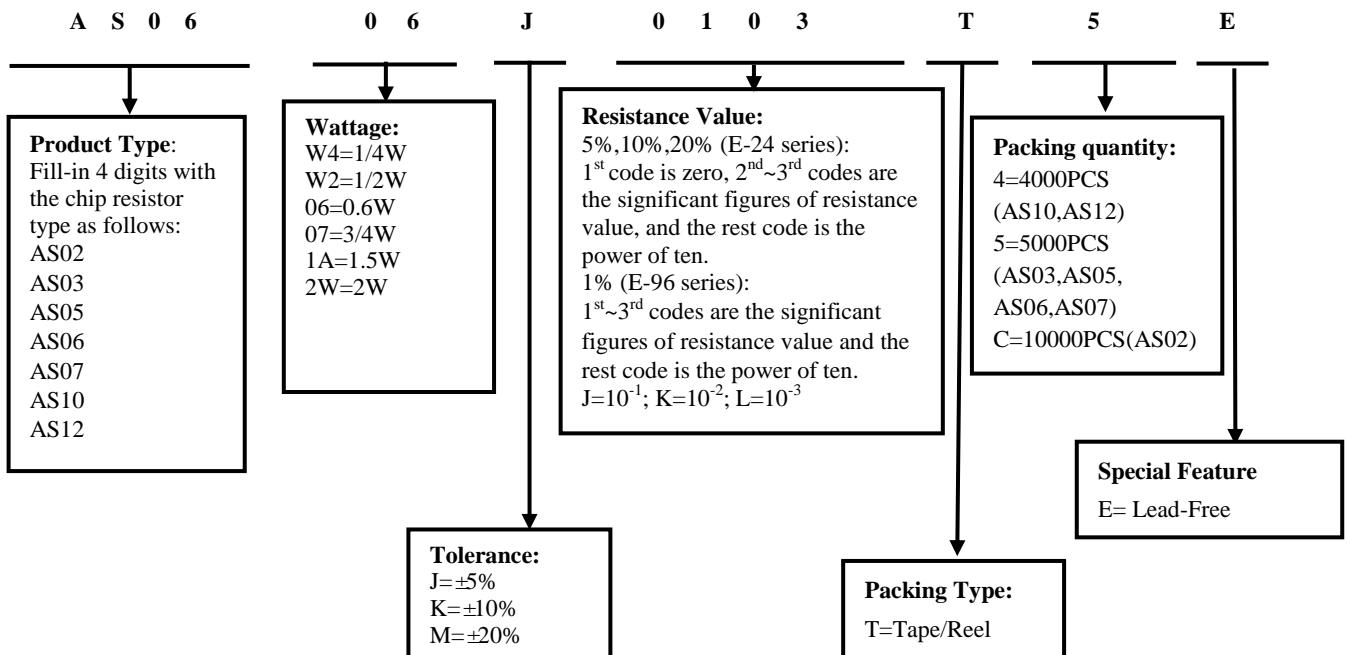

4. Marking

4.1 For AS02 size. Due to the very small size of the resistor's body, there is no marking on the body.



4.2 ±5% ±10% ±20% tolerance products (E-24 series):
3 codes.

1st~2nd codes are the significant figures of resistance value, and the rest code is the power of ten.



333 → 33KΩ

4.3 ±5% ±10% ±20% Tolerance:

below 10Ω Show as following, read alphabet "R" as decimal point.



2R2 → 2.2Ω

5. Dimension

Type	Dimension(mm)				
	L	W	H	A	B
AS02(0402)	1.00±0.10	0.50±0.05	0.35±0.05	0.20±0.10	0.25±0.10
AS03(0603)	1.60±0.10	0.80±0.10	0.45±0.10	0.30±0.20	0.30±0.20
AS05(0805)	2.00±0.15	1.25 +0.15/-0.10	0.55±0.10	0.40±0.20	0.40±0.20
AS06(1206)	3.10±0.15	1.55 +0.15/-0.10	0.55±0.10	0.45±0.20	0.45±0.20
AS07(1210)	3.10±0.10	2.60±0.20	0.55±0.10	0.50±0.25	0.50±0.20
AS10(2010)	5.00±0.10	2.50±0.20	0.55±0.10	0.60±0.25	0.50±0.20
AS12(2512)	6.35±0.10	3.20±0.20	0.55±0.10	0.60±0.25	0.50±0.20

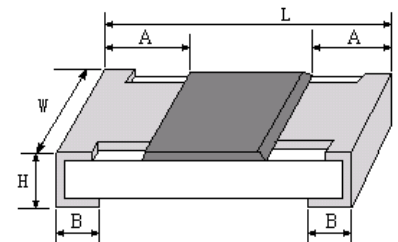

6. Resistance Range

Type	Power Rating at 70°C	Resistance Range		
		5%	10%	20%
AS02	1/8W	1Ω~10MΩ	1Ω~10MΩ	1Ω~10MΩ
AS03	1/4W	1Ω~10MΩ	1Ω~10MΩ	1Ω~10MΩ
AS05	1/2W	1Ω~10MΩ	1Ω~10MΩ	1Ω~10MΩ
AS06	0.6W	1Ω~10MΩ	1Ω~10MΩ	1Ω~10MΩ
AS07	3/4W	1Ω~10MΩ	1Ω~10MΩ	1Ω~10MΩ
AS10	1.5W	1Ω~10MΩ	1Ω~10MΩ	1Ω~10MΩ
AS12	2W	1Ω~10MΩ	1Ω~10MΩ	1Ω~10MΩ

7. Ratings

Type	Max. Working Voltage	Max. Overload Voltage	Dielectric withstanding Voltage	Operating Temperature
AS02	50V	100V	--	-55°C~155°C
AS03	75V	150V	300V	-55°C~155°C
AS05	150V	300V	500V	-55°C~155°C
AS06	200V	400V	500V	-55°C~155°C
AS07	200V	500V	500V	-55°C~155°C
AS10	400V	800V	500V	-55°C~155°C
AS12	500V	1000V	500V	-55°C~155°C

8. Soldering pad size recommended

Type	Dimension(mm)			
	A	B	C	D
AS03	0.8±0.05	0.65±0.05	0.8±0.05	2.4±0.05
AS05	1.0±0.1	1.0±0.1	1.4±0.1	3.0±0.1
AS06	2.0±0.1	1.1±0.1	1.8±0.1	4.2±0.1
AS07	2.0±0.1	1.1±0.1	3.0±0.1	4.2±0.1
AS10	3.6±0.1	1.4±0.1	3.0±0.1	6.4±0.1
AS12	4.9±0.1	1.35±0.1	3.7±0.1	7.6±0.1

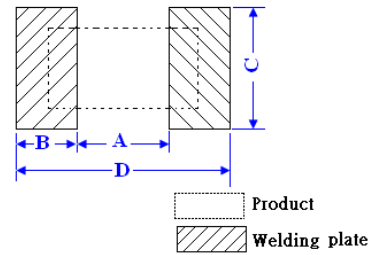

9. Derating Curve

Power rating will change based on continuous load at ambient temperature from -55 to 155°C. It is constant between -55 to 70°C, and derate to zero when temperature rise from 70 to 155°C.

Voltage rating:
Resistors shall have a rated direct-current (DC) continuous working voltage or an approximate sine-wave root-mean-square (RMS) alternating-current (AC) continuous working voltage at commercial-line frequency and waveform corresponding to the power rating, as determined from the following formula:

$$RCWV = \sqrt{P \times R}$$

Remark: RCWV: Rating Continuous Working Voltage (Volt.) P: power rating (Watt) R: nominal resistance (Ω)

In no case, the rated DC or RMS AC continuous working voltage must be greater than the applicable maximum value. The overload voltage is 2.5 times RCWV or Max. Overload voltage whichever is lower.

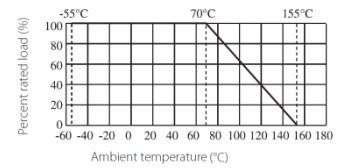

10. One-pulse Limiting Electric Power

Curve of Pulse Duration :

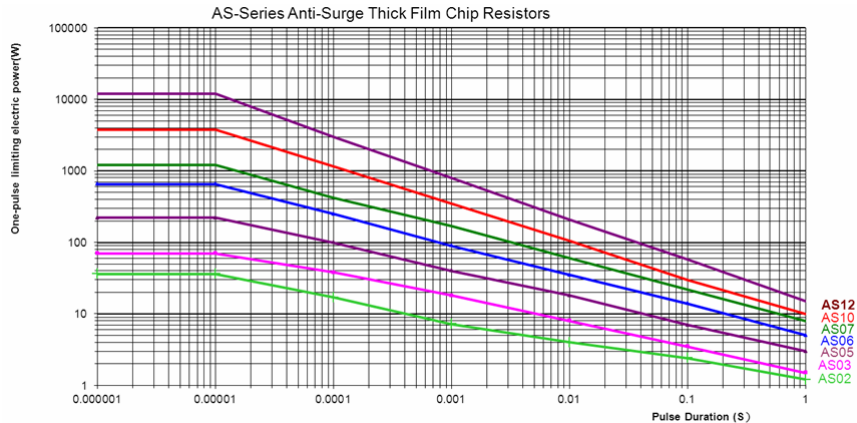

Pulse Voltage Limit :

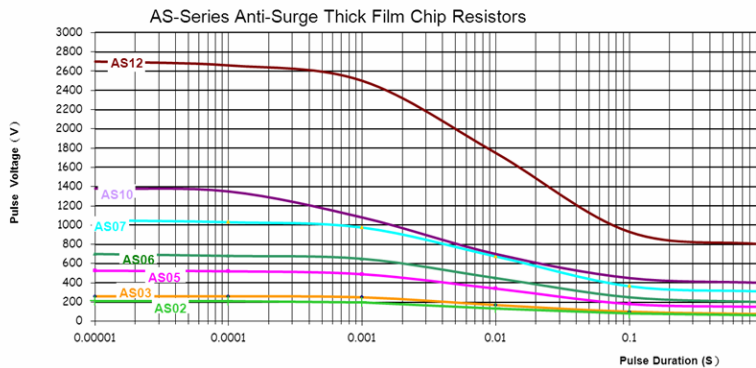

11. Structure

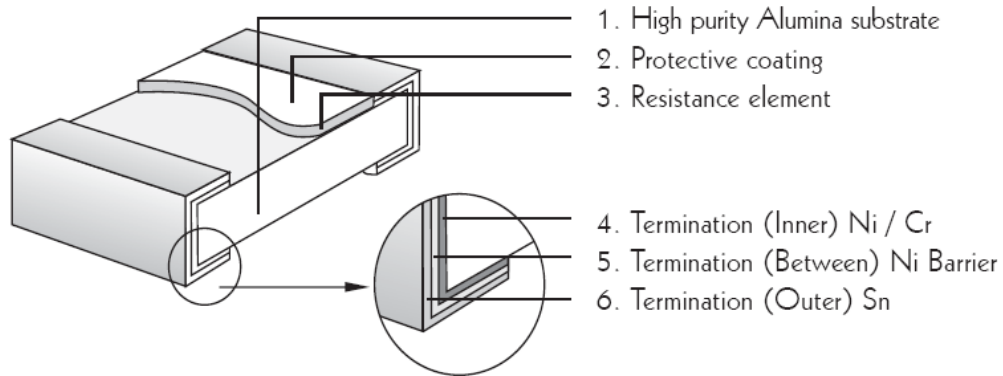

12. Performance Specification

Characteristic	Limits	Ref. Standards	Test Method
Operational life	$\pm(3.0\%+0.1\Omega)$	MIL-STD-202	125°C, at 36% of operating power, 1000H(1.5 hours "ON", 0.5 hour "OFF").
Electrical Characterization	$1\Omega \leq R \leq 10\Omega: \pm 400\text{PPM}/^\circ\text{C}$ $10\Omega < R \leq 10\text{M}: \pm 100\text{PPM}/^\circ\text{C}$	GB/T 5729 4.8 JIS-C-5201 4.8 IEC60115-1 4.8	Natural resistance changes per temp. Degree centigrade $\frac{R_2-R_1}{R_1(t_2-t_1)} \times 10^6$ (PPM/°C) R ₁ : Resistance Value at room temperature (t ₁) ; R ₂ : Resistance at test temperature (t ₂) t ₁ : +25 °C or specified room temperature t ₂ : Test temperature (-55°C or 125 °C)
Short-time overload	$\pm(1.0\%+0.1\Omega)$	GB/T 5729 4.13 JIS-C-5201 4.13 IEC60115-1 4.13	Permanent resistance change after the application of a potential of 2.5 times RCWV or Max. Overload Voltage whichever less for 5 seconds..
External Visual	No Mechanical Damage	MIL-STD-883 Method 2009	Electrical test not required. Inspect device construction, marking and workmanship
Physical Dimension	Reference 5.0 Dimension Standards	JESD22 MH Method JB-100	Verify physical dimensions to the applicable device detail specification. Note: User(s) and Suppliers spec. Electrical test not required.
Resistance to Solvent	Marking Unsmearred	MIL-STD-202 Method 215	Note: Add Aqueous wash chemical – OKEM Clean or equivalent. Do not use banned solvents.
Terminal Strength	Not broken	JIS-C-6429	Force of 1.8kg for 60 seconds.
High Temperature Exposure (Storage)	$\pm(3.0\%+0.1\Omega)$	MIL-STD-202 Method 108	1000hrs. @T=155°C. Unpowered. Measurement at 24±2 hours after test conclusion.
Temperature Cycling	$\pm(1.0\%+0.05\Omega)$	JESD22 Method JA-104	1000 Cycles (-55°C to +155°C). Measurement at 24±2 hours after test conclusion.
Biased Humidity	$\pm(3.0\%+0.1\Omega)$	MIL-STD-202 Method 103	1000 hours 85°C, 85%RH. Note: Specified conditions: 10% of operating power. Measurement at 24±2 hours after test conclusion.
Mechanical Shock	$\pm(1.0\%+0.1\Omega)$	MIL-STD-202 Method 213	Wave Form: Tolerance for half sine shock pulse. Peak value is 100g's. Normal duration (D) is 6.
Vibration	$\pm(1.0\%+0.1\Omega)$	MIL-STD-202 Method 204	5g's for 20 min., 12cycle each of 3 orientations. Note: Use 8"×5"PCB. 031" thick 7 secure points on one long side and 2 secure points at corners of opposite sides. Parts mounted within 2" from any secure point. Test from 10-2000Hz.

ESD	$\pm(3.0\%+0.1\Omega)$	AEC-Q200-002	With the electrometer in direct contact with the discharge tip, verify the voltage setting at levels of $\pm 500V, \pm 1KV, \pm 2KV, \pm 4KV, \pm 8KV$. The electrometer reading shall be within $\pm 10\%$ for voltages from 500V to $\cong 800V$.
Solderability	95% coverage Min.	J-STD-002	For both leaded & SMD. Electrical test not required. Magnification 50X. Conditions: a) Method B 4hrs at 155°C dry heat, the dip in bath with $245\pm 3^\circ C, 5\pm 0.5s$. b) Method D: at $260\pm 3^\circ C, 30\pm 0.5s$.
Board Flex	$\pm(1\%+0.05\Omega)$	JIS-C-6429	2mm (Min)
Resistance to Soldering Heat	$\pm(1\%+0.05\Omega)$	MIL-STD-202 Method 210	Condition B No per-heat of samples. Dipping the resistor into a solder bath having a temperature of $260^\circ C \pm 5^\circ C$ and hold it for 10 ± 1 seconds

13. Soldering Condition

(This is for recommendation, please customer perform adjustment according to actual application)

13.1 Recommend Reflow Soldering Profile : (solder : Sn96.5 / Ag3 / Cu0.5)

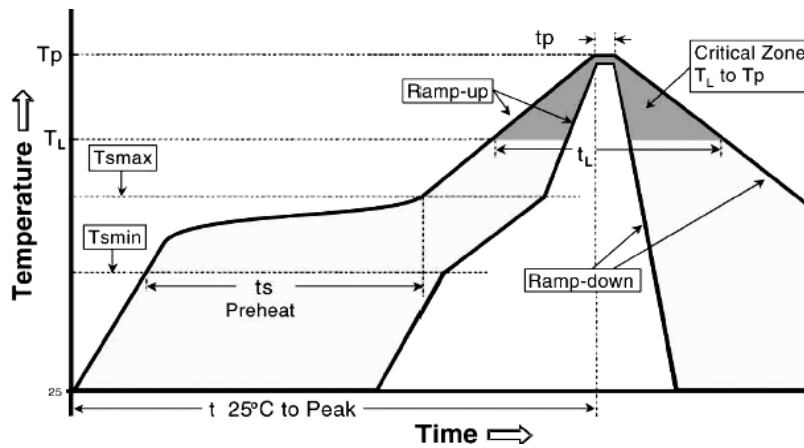

Profile Feature	Lead (Pb)-Free solder
Preheat: Temperature Min ($T_{s_{min}}$) Temperature Max ($T_{s_{max}}$) Time ($T_{s_{min}}$ to $T_{s_{max}}$) (t_s)	150°C 200°C 60 -120 seconds
Average ramp-up rate: ($T_{s_{max}}$ to T_p)	3°C / second max.
Time maintained above : Temperature (T_L) Time (t_L)	217°C 60-150 seconds
Peak Temperature (T_p)	260°C
Time within $+0/-5^\circ C$ of actual peak Temperature (t_p) ²	10 seconds
Ramp-down Rate	6°C/second max.
Time 25°C to Peak Temperature	8minutes max.

Allowed Re-flow times : 2 times

Remark : To avoid discoloration phenomena of chip on terminal electrodes, please use N2 Re-flow furnace .

13.2 Recommend Wave Soldering Profile : (Apply to 0603 and above size)

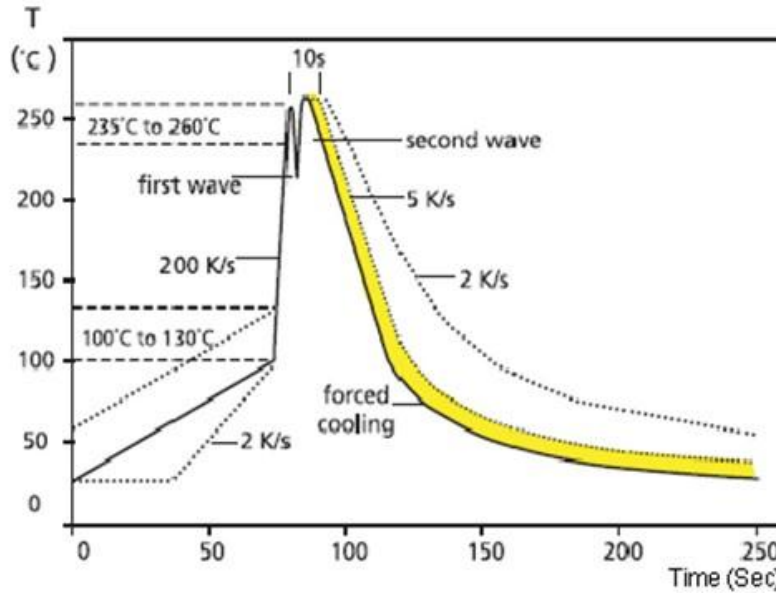

13. Packing

13.1 Dimension of Paper Taping : (Unit: mm)

Type	A ±0.10	B ±0.10	C ±0.05	$\Phi D_{+0.1}^{-0.1}$	E ±0.1	F ±0.05	G ±0.1	W ±0.2	T ±0.05
AS02	0.65	1.20	2.00	1.50	1.75	3.50	4.00	8.00	0.42

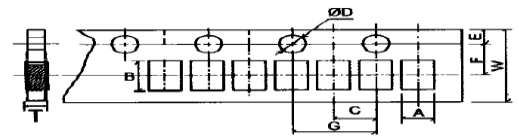

TYPE	A ± 0.2	B ± 0.2	C ± 0.05	$\Phi D_{-0}^{+0.1}$	E ± 0.1	F ± 0.05	G ± 0.1	W ± 0.2	T ± 0.10
AS03	1.10	1.90	2.00	1.50	1.75	3.50	4.00	8.00	0.67
AS05	1.65	2.40	2.00	1.50	1.75	3.50	4.00	8.00	0.81
AS06	2.00	3.60	2.00	1.50	1.75	3.50	4.00	8.00	0.81
AS07	2.80	3.50	2.00	1.50	1.75	3.50	4.00	8.00	0.75

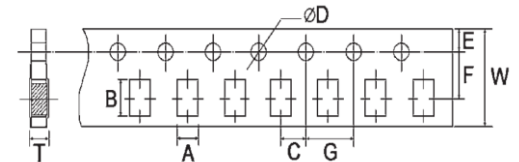

13.2 Dimension of plastic taping: (Unit: mm)

Type	A ±0.2	B ±0.2	C ±0.05	$\Phi D_{-0}^{+0.1}$	$\Phi D1_{-0}^{+0.25}$	E ±0.1	F ±0.05	G ±0.1	W ±0.2	T ±0.1
AS10	2.90	5.60	2.00	1.50	1.50	1.75	5.50	4.00	12.00	1.00
AS12	3.50	6.70	2.00	1.50	1.50	1.75	5.50	4.00	12.00	1.00

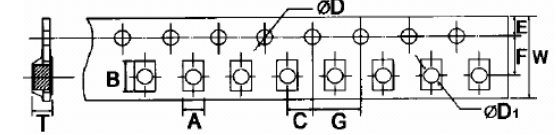

13.3 Dimension of Reel : (Unit: mm)

Type	Taping	Size	A±0.5	B±0.5	C±0.5	D±1	M±2	W±1
AS02	Paper	10,000pcs	2.0	13.0	21.0	60.0	178.0	10.0
AS03			2.0	13.0	21.0	60.0	178.0	10.0
AS05			2.0	13.0	21.0	60.0	178.0	10.0
AS06			2.0	13.0	21.0	60.0	178.0	10.0
AS07			2.0	13.0	21.0	60.0	178.0	10.0
AS10	Embossed	4000pcs	2.0	13.0	21.0	60.0	178.0	13.8
AS12			2.0	13.0	21.0	60.0	178.0	13.8

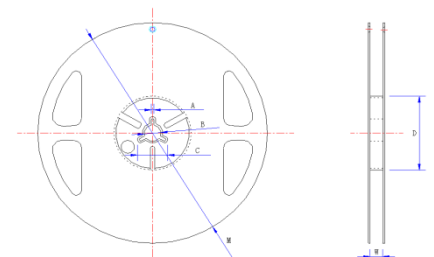

14. Note

14.1. UNI-ROYAL recommend products store in warehouse with temperature between 15 to 35°C under humidity between 25 to 75%RH.

Even under storage conditions recommended above, solder ability of products will be degraded stored over 1 year old.

14.2. Cartons must be placed in correct direction which indicated on carton, otherwise the reel or wire will be deformed.

14.3. Storage conditions as below are inappropriate:

- a. Stored in high electrostatic environment
- b. Stored in direct sunshine, rain, snow or condensation.
- c. Exposed to sea wind or corrosive gases, such as Cl₂, H₂S, NH₃, SO₂, NO₂, etc.

15. Record

Version	Description	Page	Date	Amended by	Checked by
1	First version	1~7	Jun.03, 2020	Haiyan Chen	Yuhua Xu
2	Modify the test of ESD	6	Sep.26, 2023	Song Nie	Haiyan Chen
3	Modify ESD test	6	Feb.19, 2024	Song Nie	Haiyan Chen

© Uniroyal Electronics Global Co., Ltd. All rights reserved. Specification herein will be changed at any time without prior notice.