

**UNI-ROYAL**  
厚聲集團

# DATA SHEET

**Product Name** Resistor Network-SIP Series

---

**Part Name** RPL Series

**File No.** DIP-SP-021

## **Uniroyal Electronics Global Co., Ltd.**

88#, Longteng Road, Economic & Technical Development Zone, Kunshan, Jiangsu, China

Tel +86 512 5763 1411 / 22 /33

Email [marketing@uni-royal.cn](mailto:marketing@uni-royal.cn)

Manufacture Plant Uniroyal Electronics Industry Co., Ltd.

Aeon Technology Corporation

Royal Electronic Factory (Thailand) Co., Ltd.

Royal Technology (Thailand) Co., Ltd.

## 1. Scope

- 1.1 This datasheet is the characteristics of Power Resistor Network-SIP Series manufactured by UNI-ROYAL.
- 1.2 Miniature, high density packaging
- 1.3 High reliability RuO<sub>2</sub>

## 2. Part No. System

The standard Part No. includes 14 digits with the following explanation:

2.1 For Network Resistors, these 4 digits are to indicate the product type but if the product type has only 3 digits, the 4<sup>th</sup> digit will be “0”

Example: RPLA=Resistor Network

2.2 5<sup>th</sup>~6<sup>th</sup> digits:

2.2.1 For Resistor Network, since the power rating is fixed as 1/8W for a circuit, the 5<sup>th</sup> & 6<sup>th</sup> digit is to be used to denote the number of pins required.

Example: 08=8PINS 10=10PINS

2.3 The 7<sup>th</sup> digit is to denote the Resistance Tolerance. The following letter code is to be used for indicating the standard Resistance Tolerance.

G=±2% J=±5%

2.4 The 8<sup>th</sup> to 11<sup>th</sup> digits is to denote the Resistance Value.

2.4.1 The following numbers and the letter codes are to be used to indicate the number of zeros in the 11<sup>th</sup> digit:

0=10<sup>0</sup> 1=10<sup>1</sup> 2=10<sup>2</sup> 3=10<sup>3</sup> 4=10<sup>4</sup> 5=10<sup>5</sup> J=10<sup>-1</sup>

2.5 The 12<sup>th</sup>, 13<sup>th</sup> & 14<sup>th</sup> digits.

2.5.1 The 12<sup>th</sup> digit is to denote the Packaging Type with the following codes:

B=Bulk/Box

2.5.2 The 13<sup>th</sup> digit is normally to indicate the Packing Quantity, This digit should be filled with “0” for the Cement products with “Bulk/Box” packing requirements.

2.5.3 For Network, the 14<sup>th</sup> digit alone can use to denote special features of additional information with the following codes or standard product

Example: E=For “Environmental Protection, Lead Free type” of Network Resistors.

## 3. Ordering Procedure

(Example: RPL-A 10PIN ±2% 10KΩ B/B)

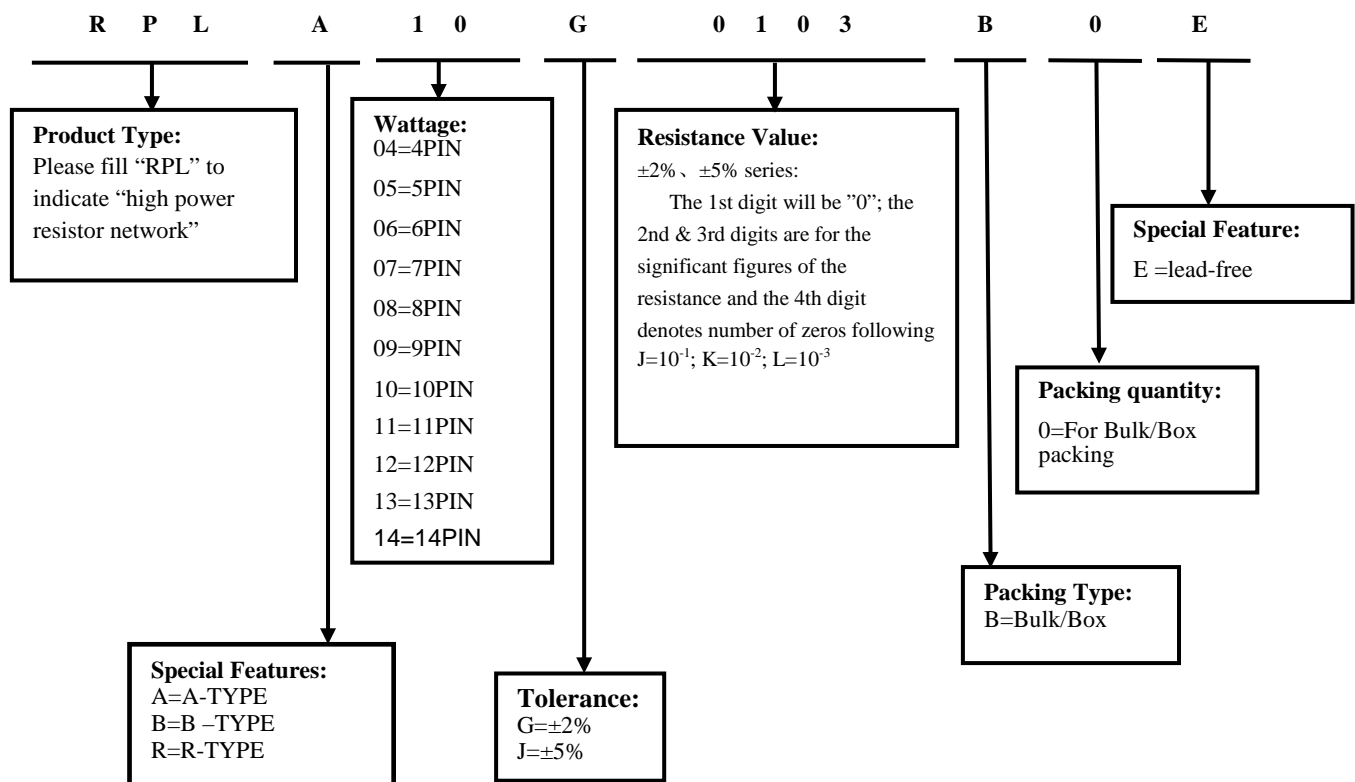

**4. Marking**

A Type & B Type

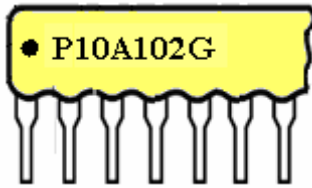

R Type

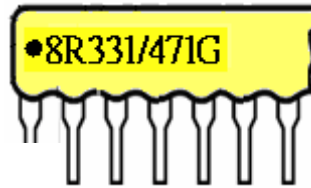

- (1)●: Pin one indicator
- (2) P: Power type
- (3) 10: Number of Pins
- (4) A: Circuit type(A type 、 B type and R type)
- (5) 331& 331/471: Resistance code  
 First 2 digits are significant, third digit represents the number of zeros to follow.
- (6) G: Resistance tolerance±2%, J: ±5%, F: ±1%

**5. Ratings & Dimension**

5.1 Ratings:

Type	Power (W)	Max Working Voltage	Max Overload Voltage	Dielectric Withstanding Voltage	Resistance Range	Tolerance	Operating temperature
RPL-A	0.20	100V	150V	200V	10Ω~1MΩ	±2% 、 ±5%	-55℃~155℃
RPL-B	0.30	100V	150V	200V	10Ω~1MΩ	±2% 、 ±5%	-55℃~155℃
RPL-R	0.20	100V	150V	200V	100Ω~10KΩ	±2% 、 ±5%	-55℃~155℃

Remark: RPL-R Dual Value (R1/R2) (Ohm)

160Ω/240Ω	220Ω/270Ω	330Ω/390Ω	1.5KΩ/3.5KΩ
180Ω/390Ω	220Ω/330Ω	330Ω/470Ω	3KΩ/6.2KΩ

Special Value available on a case to case basis.

5.2 Dimension (mm) :

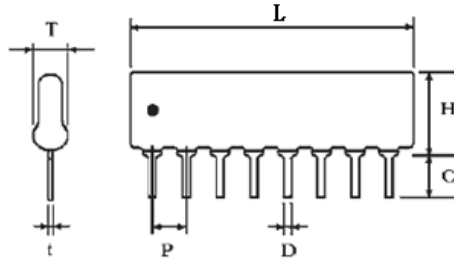

Type	L(max)	H(max)	C	+0.5 -0.3	T(max)	t±0.05	P±0.2	D±0.1
4PIN	10.2	5.08	3.3		2.5	0.25	2.54	0.5
5PIN	12.7							
6PIN	15.3							
7PIN	17.8							
8PIN	20.4							
9PIN	22.9							
10PIN	25.4							
11PIN	28.0							
12PIN	30.5							
13PIN	33.1							
14PIN	35.6							

5.3 Package Power Ratings(Watts)

Pkg.	Package Power Rating	Pkg.	Package Power Rating
4	0.50W	10	1.25W
5	0.63W	11	1.38W
6	0.75W	12	1.50W
7	0.88W	13	1.63W
8	1.00W	14	1.75W
9	1.13W		

6. Derating Curve

Power rating will change based on continuous load at ambient temperature from -55 to 155°C.

It is constant between -55 to 70°C, and derate to zero when temperature rise from 70 to 155°C.

Voltage rating:

Resistors shall have a rated direct-current (DC) continuous working voltage or an approximate sine-wave root-mean-square (RMS) alternating-current (AC) continuous working voltage at commercial-line frequency and waveform corresponding to the power rating, as determined from the following formula:

$$RCWV = \sqrt{P \times R}$$

Remark: RCWV: Rating Continuous Working Voltage (Volt) P: power rating (Watt) R: nominal resistance (Ω)

In no case shall the rated DC or RMS AC continuous working voltage be greater than the applicable maximum value.

The overload voltage is 2.5 times RCWV or Max. Overload voltage whichever is lower.

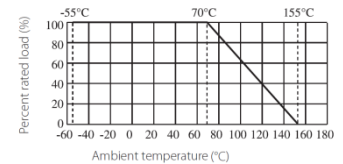

## 7. Circuits Construction

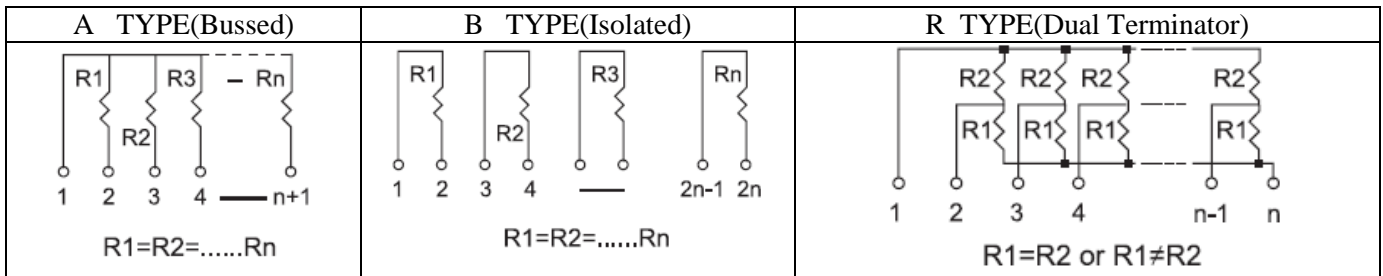

## 8. Performance Specification

Characteristic	Limits	Test Methods (GB/T5729&JIS-C-5201&IEC60115-1)
Temperature Coefficient	50Ω~1MΩ: ±100PPM/°C <50Ω&>1MΩ: ±250PPM/°C	4.8 Natural resistance changes per temp. Degree centigrade $\frac{R_2-R_1}{R_1(t_2-t_1)} \times 10^6 \text{ (PPM/°C)}$ R <sub>1</sub> : Resistance Value at room temperature ( t <sub>1</sub> ) ; R <sub>2</sub> : Resistance at test temperature ( t <sub>2</sub> ) t <sub>1</sub> : +25°C or specified room temperature t <sub>2</sub> : Test temperature ( -55°C or 125°C )
Short-time overload	$\Delta R/R \leq \pm(0.25\%+0.1\Omega)$	4.13 Permanent resistance change after the application of a potential of 2.5 times rcwv for 5 seconds.
Insulation Resistance	≥10,000MΩ	4.6 Apply 100V DC between protective coating and termination for 1 Min then measure
Dielectric withstanding voltage	No evidence of flashover mechanical damage, arcing or insulation break down.	4.7 resistors shall be clamped in the trough of a 90°C metallic v-block and shall be tested at ac potential respectively specified in the given list of each product type for 60-70 seconds.
Terminal strength	$\Delta R/R \leq \pm(0.25\%+0.1\Omega)$	4.16 Direct load: Resistance to a 2.5 Kg direct load for 10 seconds in the direction of the longitudinal axis of the terminal leads.
Resistance to soldering heat	$\Delta R/R \leq \pm(0.5\%+0.1\Omega)$	4.18 Dip the resistor into a solder bath having a temperatuer of 260°C±5°C and hold it for 10±1seconds.
Solderability	Coverage must be over 95%.	Wave Solder: Test temperature of solder: 245°C±3°C Dipping time in solder: 2-3seconds

Rapid change of temperature	$\Delta R/R \leq \pm(0.5\%+0.1\Omega)$	4.19 30 min at -55 °C and 30 min at 155°C; 100 cycles
Load life in humidity	$\Delta R/R \leq \pm(1\%+0.1\Omega)$	7.9 Resistance change after 1,000 hours (1.5 hours “ON”, 0.5 hour “OFF”) at RCWV in a humidity test chamber controlled at 40°C±2°C and 90 to 95% relative humidity.
Load life	$\Delta R/R \leq \pm(0.5\%+0.1\Omega)$	4.25.1 permanent resistance change after 1,000 hours operating at RCWV with duty cycle of 1.5 hours “ON”, 0.5 hour “OFF” at 70 °C±2°C ambient.
Low Temperature Storage	$\Delta R/R \leq \pm(1\%+0.1\Omega)$	IEC 60068-2-1 (Aa) Lower limit temperature ∙ for 2H.
High Temperature Exposure	$\Delta R/R \leq \pm(1\%+0.1\Omega)$	MIL-STD-202 108A Upper limit temperature ∙ for 16H.

## 9. Packing

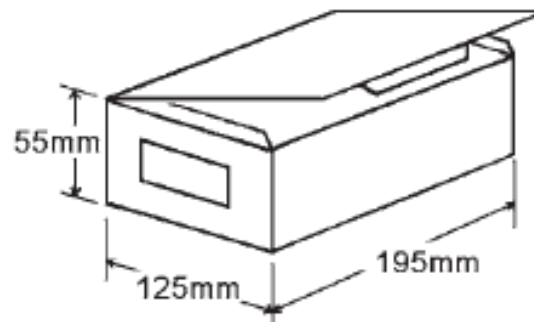

UNIT: mm

PIN	Weight of 1,000pcs	Quantity Per Bag	Quantity Per Box	Quantity Per Carton
4	210g	200	1,000	30,000
5	250g	200	1,000	30,000
6	320g	200	1,000	30,000
7	360g	200	1,000	30,000
8	430g	200	1,000	30,000
9	450g	200	1,000	30,000
10	530g	200	1,000	30,000
11	600g	100	500	15,000
12	650g	100	500	15,000
13	710g	100	500	15,000
14	770g	100	500	15,000

## 10. Note

- 10.1. UNI-ROYAL recommend products store in warehouse with temperature between 15 to 35°C under humidity between 25 to 75%RH.  
Even under storage conditions recommended above, solder ability of products will be degraded stored over 1 year old.
- 10.2. Cartons must be placed in correct direction which indicated on carton, otherwise the reel or wire will be deformed.
- 10.3. Storage conditions as below are inappropriate:
  - a. Stored in high electrostatic environment
  - b. Stored in direct sunshine, rain, snow or condensation.
  - c. Exposed to sea wind or corrosive gases, such as Cl<sub>2</sub>, H<sub>2</sub>S, NH<sub>3</sub>, SO<sub>2</sub>, NO<sub>2</sub>, Br etc.

**11. Record**

Version	Description	Page	Date	Amended by	Checked by
1	First version	1~7	Mar.20, 2018	Haiyan Chen	Nana Chen
2	Modify characteristic	5~6	Feb.21, 2019	Haiyan Chen	Yuhua Xu
3	Modify the temperature coefficient test conditions	4	Nov.07, 2022	Haiyan Chen	Yuhua Xu

© Uniroyal Electronics Global Co., Ltd. All rights reserved. Specification herein will be changed at any time without prior notice